



The 6300 Series meets or exceeds the requirements of MIL-C-62482 Series II and the dimensional requirements of the MS numbers listed below. These connectors are supplied with tin plated mild steel shells and gold plated contacts. For severe environments, Sealtron also manufactures these connectors with 300 Series stainless steel bodies. To improve the moisture resistance these receptacles are supplied with interfacial seals which have the cork-and-bottle design.



The 8100 Series meets or exceeds the requirements of the MIL-C-26482 Rev. C. The 8112 and 8115 are dimensionally equivalent to MS3113H and MS3114H respectively, but are supplied without the interfacial seal. MS3112 does not specifically provide for a hermetic class, however our 8113 Series has the same mounting and mating characteristics and can be used when a flange mount is desired.



The 8300 Series meets or exceeds requirements of the latest revision of MIL-C-26482. The 8312 and 8315 are dimensionally equivalent to MS3113H and MS3114H and are supplied with an interfacial seal. MS3112 does not specifically provide for a hermetic design, however our 8313 Series has the same mounting and mating characteristics and can be used when a flange mount is desired.

How-To-Order

EXAMPLE

8115-14-19PX-SP-A3

8115 Shell Design
 14 Shell Size
 19P Pin Arrangement
 X Alternative Insert Position
 SP Pin Design
 AP Finish (fused tin over copper)

Pin Design
 SP Solder Pot
 FP Flattened & Pierced
 RR Radiused
 PT Pig-tail

INSERT ARRANGEMENTS

(Engaging Face of Pin Inserts Shown)

MIL - STD - 1669

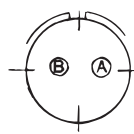

8-2
2 #20

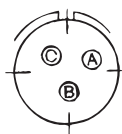

8-3
3 #20

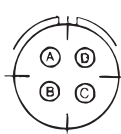

8-4
4 #20

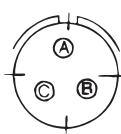

8-33
3 #20

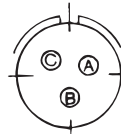

8-98
3 #20

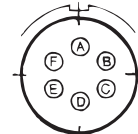

10-6
6 #20

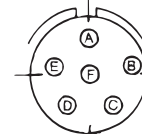

10-98
6 #20

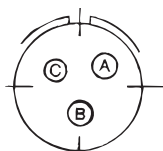

12-3
3 #16

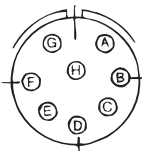

12-8
8 #20

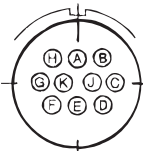

12-10
10 #20

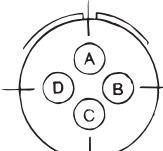

14-4
4 #12

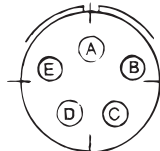

14-5
5 #16

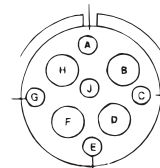

14-9
5 #20
4 #12

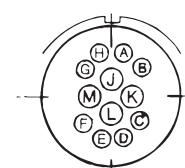

14-12
8 #20
4 #16

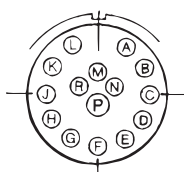

14-15
14 #20
1 #16

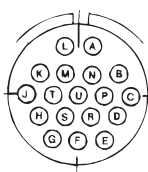

14-18
18 #20

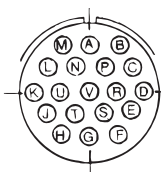

14-19
19 #20

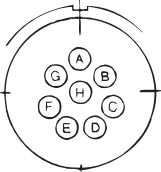

16-8
8 #16

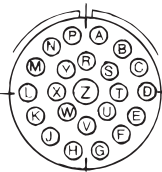

16-23
22 #20
1 #16

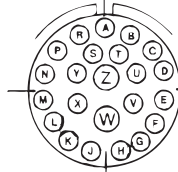

16-99
2 #16
21 #20

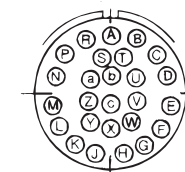

16-26
26 #20

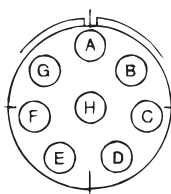

18-8
8 #12

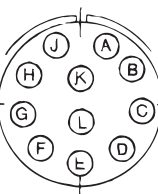

18-11
11 #16

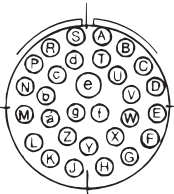

18-30
29 #20
1 #16

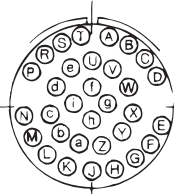

18-32
32 #20

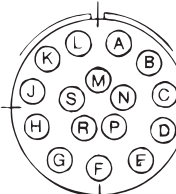

20-16
16 #16

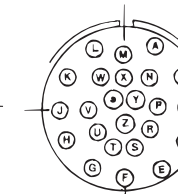

20-24
24 #20

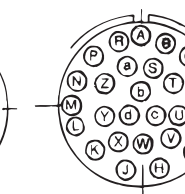

20-27
27 #20

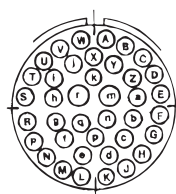

20-39
37 #20
2 #16

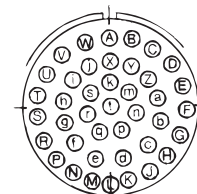

20-41
41 #20

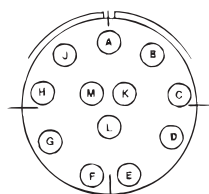

22-12
12 #12

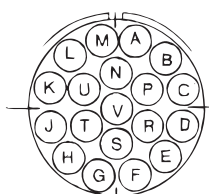

22-19
19 #12

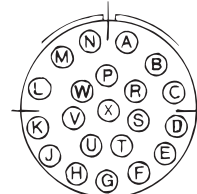

22-21
21 #16

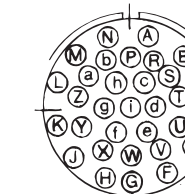

22-32
32 #20

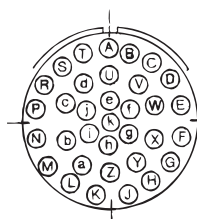

22-34
34 #20

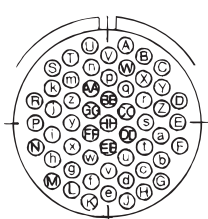

22-55
55 #20

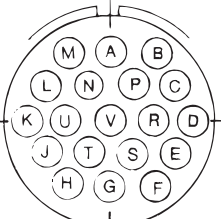

24-19
19 #12

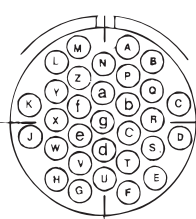

24-31
31 #16

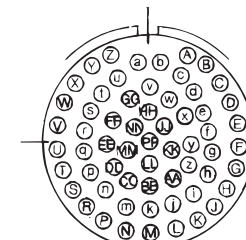

24-61
61 #20



MIL-C-26482

Hermetically Sealed Connectors

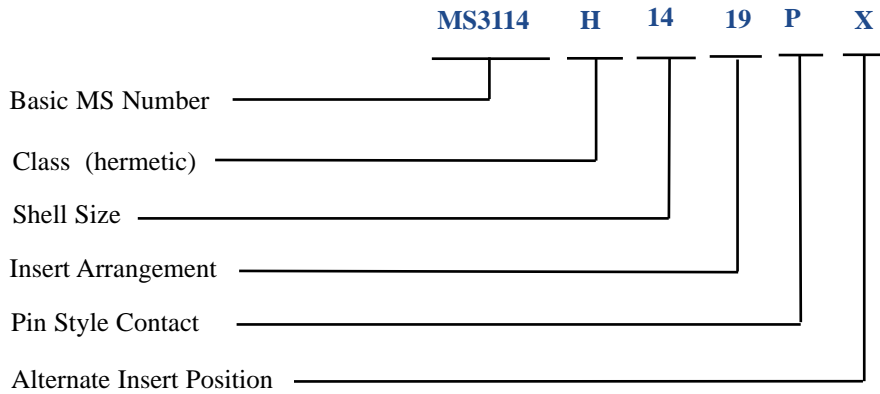

MIL-C-26482 SERIES I REVISION C SEALTRON 8100 SERIES

Standard Finish - Fused Tin Over
Copper

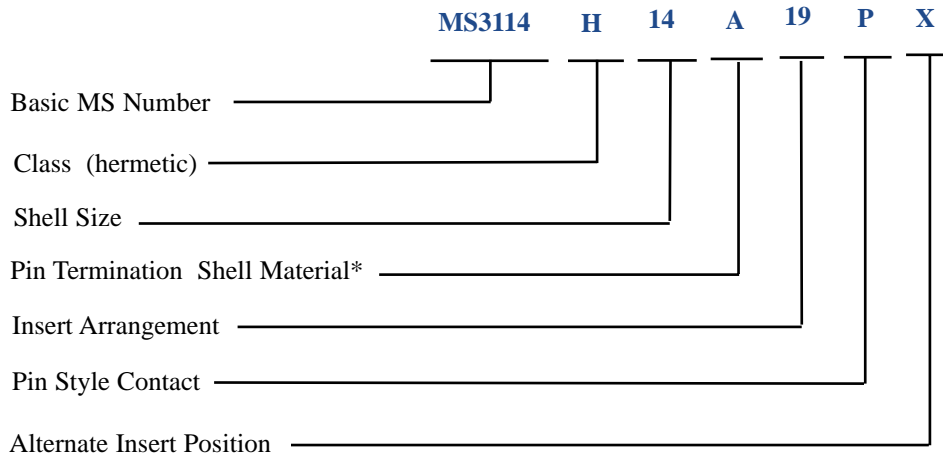

MIL-C-26482 SERIES I LATEST REVISION SEALTRON 8300 SERIES

Standard Finish - Fused Tin Over
Copper

*Pin Termination & Shell Material
A=Solder Pot Termination-CRES Shell
B=Eyelet Termination-CRES Shell
C=Solder Pot Termination-CRS Shell
Y=Eyelet Termination CRS Shell

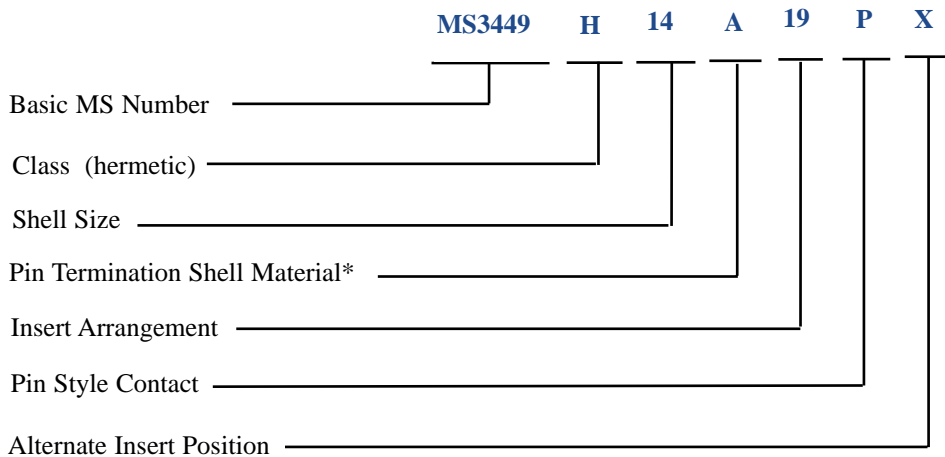

MIL-C-26482 SERIES II SEALTRON 6300 SERIES

Standard Finish - CRS Shell Plated
Fused Tin
CRES Shell - Passivated
Contacts- Gold Plated

*Pin Termination & Shell Material
A=Solder Pot Termination-CRES Shell
B=Eyelet Termination-CRES Shell
C=Solder Pot Termination-CRS Shell

8312 SERIES MS3113

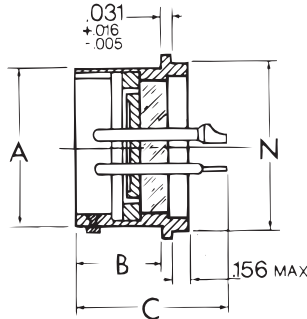
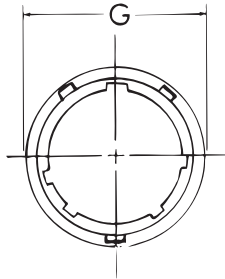

Shell Size	A +.001 -.005	G ±.010	N +.001 -.005	B +.031 -.000	C max.
8	.473	.625	.562	.411	.828
10	.590	.750	.672		
12	.750	.844	.781		
14	.875	.969	.906		
16	1.000	1.094	1.031		
18	1.125	1.218	1.156	▼	▼
20	1.260	1.312	1.250	.473	.891
22	1.375	1.438	1.375	.473	.921
24	1.500	1.563	1.500	.506	.921

8313 SERIES

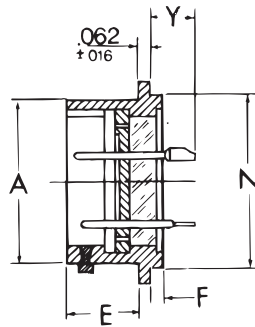
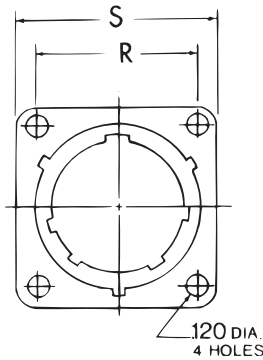

Shell Size	A +.004 -.002	E ±.015	F ±.010	N +.004 -.002	R ±.005	S ±.010	Y max.
8	.470	.447	.037	.559	.594	.812	.344
10	.587			.669	.719	.938	
12	.747			.778	.812	1.031	
14	.872			.903	.906	1.125	
16	.997			1.028	.969	1.219	
18	1.122	▼	▼	1.153	1.062	1.312	
20	1.247	.508	.038	1.247	1.156	1.438	
22	1.372	.508	.069	1.372	1.250	1.562	
24	1.497	.540	.070	1.497	1.375	1.688	▼

8315 SERIES MS3114

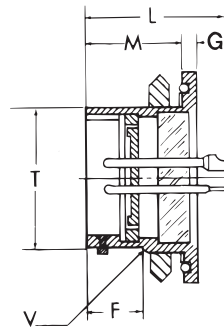
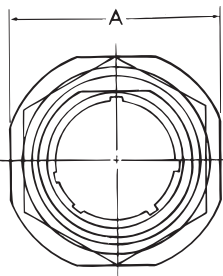

Shell Size	A max.	F min. Thrd.	G ±.020	L max.	M +.031 -.000	T	V Thread UNEF 2A
8	.954	.384	.117	1.141	.691	.474	.5625-24
10	1.078					.591	.6875-24
12	1.266					.751	.875-20
14	1.391					.876	1.000-20
16	1.516					1.001	1.125-18
18	1.641	▼	▼	▼	▼	1.126	1.250-18
20	1.828	.446	.148	1.391	.879	1.251	1.375-18
22	1.954	.446	.148	1.391	.879	1.376	1.500-18
24	2.078	.479	.148	1.453	.912	1.501	1.625-18

8112 SERIES MS3113

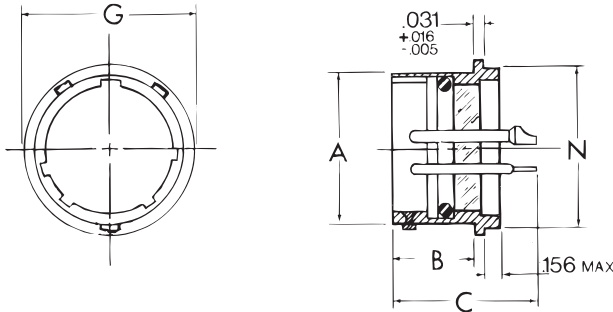

Shell Size	A +.001 -.005	G ±.010	N +.001 -.005	B +.031 -.000	C max.
8	.473	.625	.562	.411	.828
10	.590	.750	.672		
12	.750	.844	.781		
14	.875	.969	.906		
16	1.000	1.094	1.031		
18	1.125	1.218	1.156	▼	▼
20	1.260	1.312	1.250	.473	.891
22	1.375	1.438	1.375	.473	.921
24	1.500	1.563	1.500	.506	.921

8113 SERIES

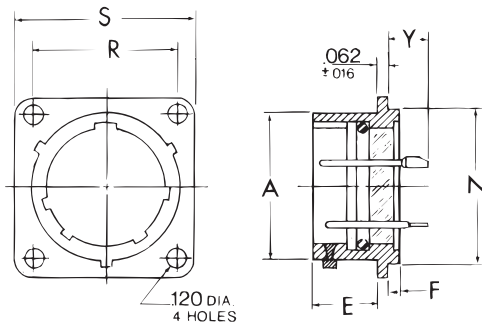

Shell Size	A +.004 -.002	E ±.015	F ±.010	N +.004 -.002	R ±.005	S ±.010	Y max.
8	.470	.447	.037	.559	.594	.812	.344
10	.587			.669	.719	.938	
12	.747			.778	.812	1.031	
14	.872			.903	.906	1.125	
16	.997			1.028	.969	1.219	
18	1.122	▼	▼	1.153	1.062	1.312	
20	1.247	.508	.038	1.247	1.156	1.438	
22	1.372	.508	.069	1.372	1.250	1.562	
24	1.497	.540	.070	1.497	1.375	1.688	▼

8115 SERIES MS3114

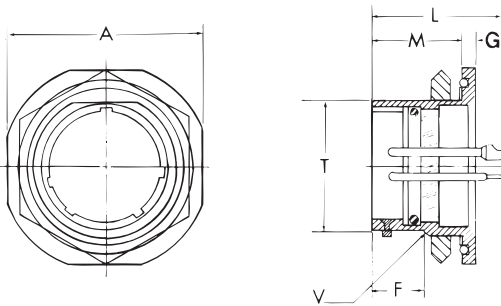

Shell Size	A max.	F min. thrd.	G ±.020	L max.	M +.031 -.000	T	V Thread UNEF 2A
8	.954	.384	.117	1.141	.691	.474	.5625-24
10	1.078					.591	.6875-24
12	1.266					.751	.875-20
14	1.391					.876	1.000-20
16	1.516					1.001	1.125-18
18	1.641	▼	▼	▼	▼	1.126	1.250-18
20	1.828	.446	.148	1.391	.879	1.251	1.375-18
22	1.954	.446	.148	1.391	.879	1.376	1.500-18
24	2.078	.479	.148	1.453	.912	1.501	1.625-18

6312 SERIES MS3443

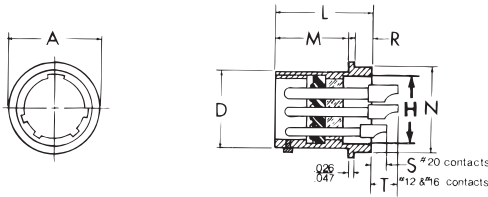

Shell Size	A ± .010	D ± .003	H min.	L max.	M ± .010	N ± .003	R ± .020	S ± .030	T ± .030
8	.625	.471	.403	.801	.588	.560	.136	.148	.218
10	.750	.588	.515			.670			
12	.844	.748	.630			.779			
14	.969	.873	.755			.904			
16	1.094	.998	.880			1.029			
18	1.218	1.123	.980	▼	▼	1.154			
20	1.312	1.248	1.105	.863	.650	1.248	▼	▼	▼
22	1.438	1.373	1.230	.895		1.373	.168	.116	.186
24	1.564	1.498	1.385	.895	▼	1.498	.168	.116	.186

6313 SERIES MS3440

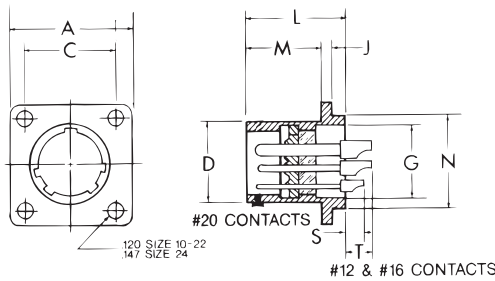

Shell Size	A max.	C	D ± .003	J ± .016	L max.	M ± .010	S ± .030	T ± .030	N ± .003	G min.
8	.828	.594	.471	.062	.801	.588	.148	.218	.560	.430
10	.954	.719	.588						.670	.515
12	1.047	.812	.748						.779	.630
14	1.141	.906	.873						.904	.755
16	1.234	.969	.998						1.029	.880
18	1.328	1.062	1.123	▼	▼	▼			1.154	.980
20	1.453	1.156	1.248	.094	.863	.650	▼	▼	1.248	1.105
22	1.578	1.250	1.373		.895		.116	.186	1.373	1.230
24	1.703	1.375	1.498	▼	.895	▼	.116	.186	1.498	1.385

6323 SERIES MS3442

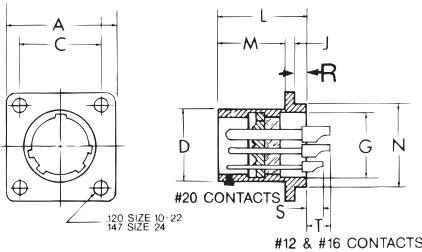

Shell Size	A max.	C typ.	D ± .003	J ± .016	L max.	M ± .010	N ± .003	R ± .010	S ± .030	T ± .030	G min.
8	1.065	.734	.471	.062	.801	.588	.560	.115	.148	.218	.403
10	1.141	.812	.588				.670				.515
12	1.266	.938	.748				.779				.630
14	1.360	1.031	.873				.904				.755
16	1.453	1.125	.998				1.029				.880
18	1.532	1.203	1.123	▼	▼	▼	1.154	▼			.980
20	1.688	1.297	1.248	.094	.863	.650	1.248	.083	▼	▼	1.105
22	1.766	1.375	1.373		.895		1.373	.115	.116	.186	1.230
24	1.891	1.500	1.498	▼	.895	▼	1.498	.115	.116	.186	1.385

6315 SERIES MS3449

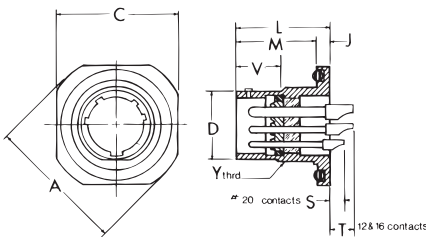

Shell Size	A + .016 - .015	C + .015 - .016	D ± .003	J	L max.	M	S ± .030	T ± .030	V ± .010	Y Thread UNEF-2A
8	1.062	.939	.471	.105	.820	.699	.104	.174	.368	.563-24
10	1.187	1.063	.588	±.008		±.008				.688-24
12	1.375	1.251	.748							.875-20
14	1.500	1.376	.873							1.000-20
16	1.625	1.501	.998							1.125-18
18	1.750	1.626	1.123	▼	▼	▼	▼	▼		1.250-18
20	1.938	1.813	1.248	.138	.920	.763	.069	.139		1.375-18
22	2.062	1.939	1.373	±.010	.920	±.009	.069	.139	▼	1.500-18
24	2.187	2.063	1.498	▼	.951	.794	.039	.109	.395	1.625-18